

A5714/...

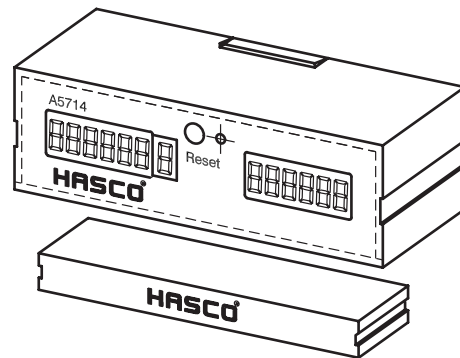

► Info

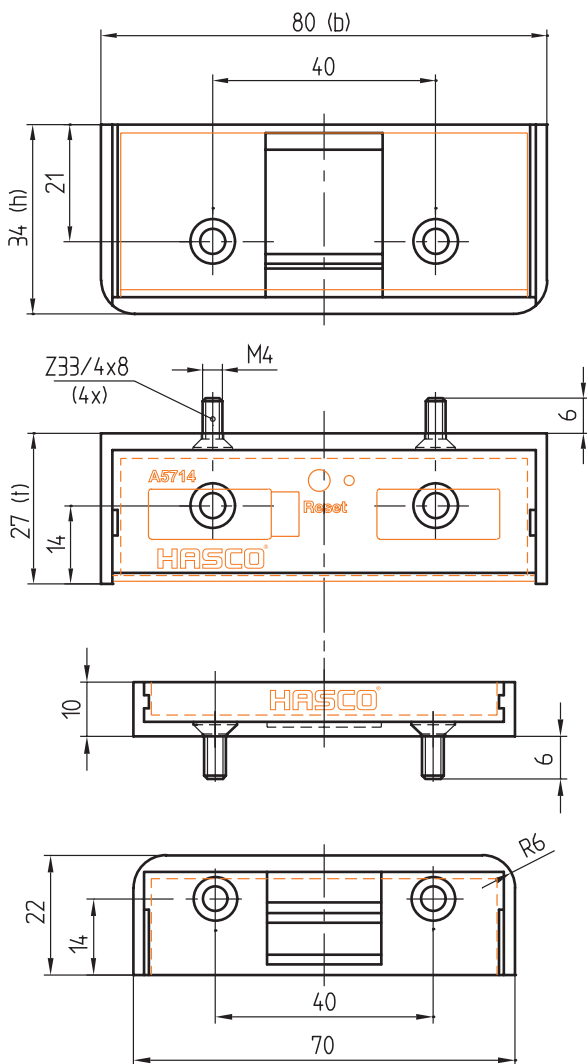

b	h	t	Nr./No.
80	34	27	A5714/80x34x27

This is trial version  
www.adultpdf.com